

Data Sheet



Article number: 204080M850A3SK

Description: E+G levelling foot
GN 40-80-M8-50-A3-SK

Note: SK With nut, External hexagon at the bottom

Measures

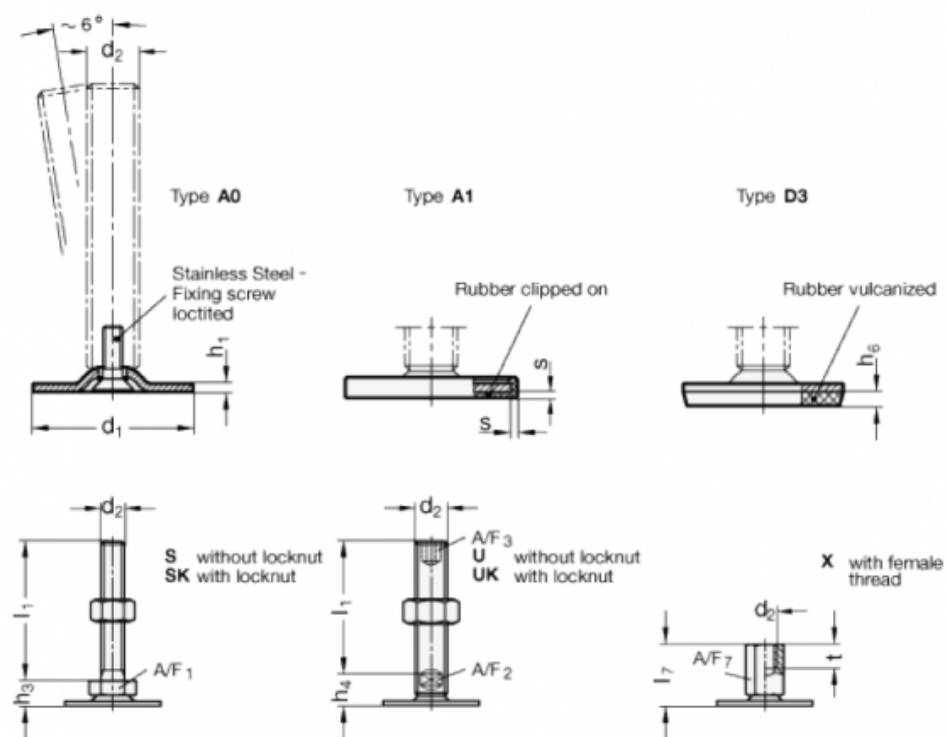

A/F1	=	17
d1	=	80
d2	=	M8
h1	=	3
h3	=	12
h6	=	5
l1	=	50
s	=	